

LIGHT

IP65 JUNCTION BOXES

Description: IP65 WATERTIGHT JUNCTION BOX WITH CONICAL CABLE GLANDS

Reference:
EV161

Characteristics:

Product type:	Watertight junction boxes with opaque cover and conical cable glands
Exterior dimensions (Height x Width x Depth):	133x180x80 mm
Dimensions of the flush-fit gap (HxWxD):	-
Number of modules:	-
Installation:	Surface
Color:	RAL 7035
Window:	White
Weight (kg):	0,25
Cable entry:	6xM25 - 4xM40
Components:	-
Materials:	Halogen-free plastic materials. Base: Shock-proof PS. Conical cable glands: PVC
Lid-window-door material:	Shock-proof PS

Technical data:

Degree of protection:	IP65
Resistance to impact:	IK07
Glow wire resistance:	650 °C
Ball pressure test:	70 °C
Ambient temperature range:	-25 °C / +40 °C
Maximum operating voltage:	1000 V AC / 1500 V DC
Rated current:	
Double insulation:	Class II

Certificates and standards:

Directive:	2014/35/EU
Standards:	IEC 60670-22
Certificates:	



Codes:

EAN:	8431044186009
Customs tariff number:	85.38.10.00
ETIM 8.0:	EC002600

LIGHT

IP65 JUNCTION BOXES

Description: IP65 WATERTIGHT JUNCTION BOX WITH CONICAL CABLE GLANDS

Reference: EV161

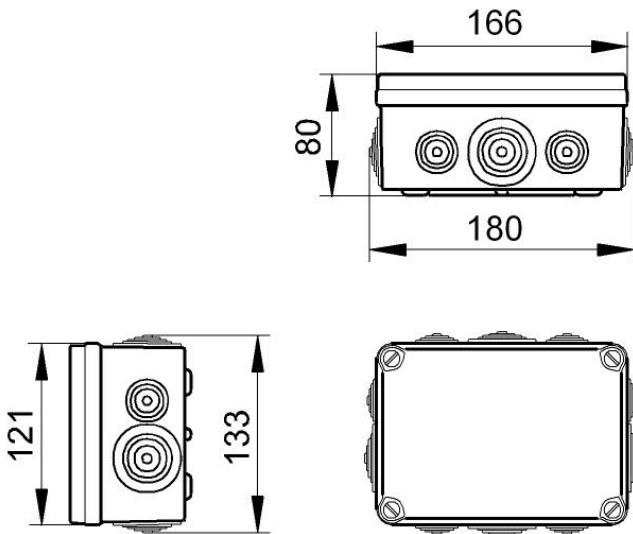

Detailed drawing:

 <http://www.ide.es/downloads/planos/pdf/EV161.pdf>

 <http://www.ide.es/downloads/planos/dxf/EV161.dxf>

 <http://www.ide.es/downloads/planos/stp/EV161.stp>

Exterior dimensions (Height x Width x Depth):

133x180x80 mm

Dimensions of the flush-fit gap (Height x Width x Depth):

-

Sustainability:

RoHS - REACH

Supply:

The boxes are supplied individually, shrink-wrapped and in multiple cardboard packaging, according to minimum packaging units. Boxes with conical cable glands are supplied with the cone assembled.

Packaging units: 45

Product end of life:

It does not require specific recycling operations.

Recommended applications:

Industrial and outdoor environments. Industrial sites, docks, swimming pools, garages, anywhere that requires a high degree of protection against dust, splashes and impacts.